

User Manual

Color Video Door Phone CAV-70PG



- Thank you for purchasing COMMAX products.
- Please carefully read this User's Guide (in particular, precautions for safety) before using a product and follow instructions to use a product exactly.
- The company is not responsible for any safety accidents caused by abnormal operation of the product.



Table of contents

1. Greetings	1
2. Safety Warning& Caution	2
3. Part names& functions	4
4. Operating.....	5
5. Configuration	6
6. How to use Lobby Inter Phone	10
7. Installing method	11
8. Wiring method	11
9. Contents	12
10. Instructions for use.	12
11. Miscellaneous.....	12
12. Specifications	13



1. Greetings

- Thank you very much for choosing COMMAX.
- Please read this manual carefully before you use the product.

2. Safety Warning & Caution

Please follow the things described below in order to prevent any danger or property damage.

 Warning It may cause a serious damage or injury if violated.  Caution It may cause a minor damage or injury if violated.	 Prohibition.  No disassembly  No touch  Must follow strictly.  Shows plugging out the power cord without an exception  Shows the warning and caution for an electric shock.  Shows the warning and caution for a fire.
--	--

Warning

Power & Installation

Please don't use several products at the same time on one power socket.
· It may cause a fire due to an abnormal overheating.



Please don't bend the power cable excessively or it may cause an electric shock.
· fire when using a damaged power cable.

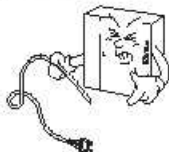

Please don't handle the power cable with a wet hand.
· It may cause an electric shock.

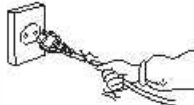

Please plug out the power cable from the socket when not using it for a long period of time.
· It may shorten the product lifespan or cause a fire.



Please don't install the product in the place where there is much oil, smoke or humidity.
· It may cause an electric shock or fire.

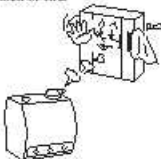

Please don't install the product with the lightning and thunder.
· It may cause an electric shock or fire.



Please don't use and connect this product with other products with different rated voltage.
· It may cause a disorder or fire.

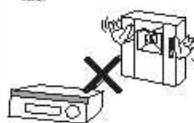

When installing the product that generates heat, please install the product away from the wall (10cm) for the ventilation.

· It may cause a fire due to the increased internal temperature.

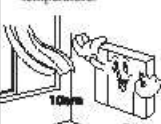

Warning

Cleaning & Use

Please don't disassemble, repair or rebuild this product arbitrarily (please contact the service center if a repair is needed).

- It may cause an electric shock or fire.



Prohibition



If an abnormal sound, burning smell or smoke is coming out of the product, please plug out the power cable and contact a service center.

- It may cause an electric shock or fire.



Please don't insert any metallic or burnable materials into the ventilation hole.

- It may cause an electric shock or fire.

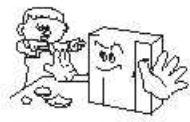

Please use only the designated batteries for the products of using DC power.

- It may cause an electric shock or fire.

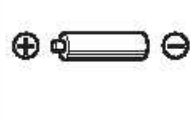

Caution

Power & Installation

Please plug the power cable firmly into the inner end

- It may cause a fire.

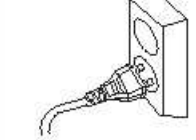

Please hold the plug tightly when unplugging the power cable (a part of the copper wire may be disconnected if the grabbing is only made on the cord when pulling out the cable).

- It may cause an electric shock or fire.

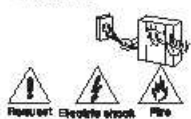

When connecting the power cables after cutting the cable, please install the product with power off

- It may cause an electric shock or fire.



When installing the product, please fix it firmly while using the wall-mounting unit and screws.

- It may cause an injury from the falling object.



Please be careful when using an AC circuit breaker since there is a possibility of an electric shock.



Please check the use voltage and current for the DC-only products and use the appropriate rectifier.

- It may cause a fire.



Please avoid direct rays of the sun or heating devices at a time of installation.

- It may cause a fire.



Please don't install the product on an unstable place or small support board.

- It may cause an injury if it falls down while in use.



Cleaning & Use

When cleaning the product, please rub it with a soft and dry cloth after plugging out the power cable. (Please don't use any chemical products such as wax, benzene, alcohol or cleanser.)



Please don't drop the product on the ground and don't apply a shock.

- It may cause a failure.

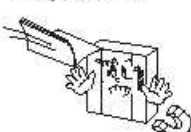

Please use the designated connection cable within the maximum calling distance designated for the product

- It may reduce the product performance.



3. Part names and functions

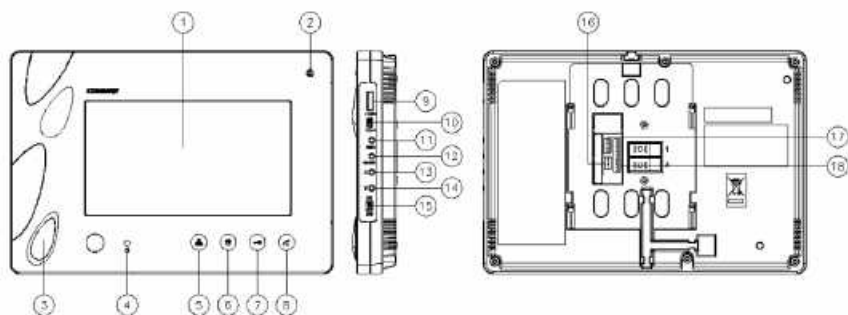

NO.	Name	NO.	Name
1	Monitor	10	Call volume control (max /min)
2	Microphone	11	MENU(menu switch)
3	Speaker	12	SELECT(select button)
4	Power indicator LED	13	UP button (^)
5	Monitoring button (individual door)	14	DOWN button (▽)
6	Guard Button	15	Power Switch
7	Door release button	16	Program Download
8	Talk button	17	Camera
9	Conversation volume	18	Guard Station/Lobby

- Conversation volume control : Control the voice level coming from the outside unit
- Call volume control : Control the call sound level (max / min)



4. Operating

1. Call from the individual entrance

- ① When the visitor presses the call button, an electronic chime sound rings and the visitor's image appears on the monitor.
- ② Conversation with the individual entrance will begin when you presses the call button. To release the door lock, press the door release button. (Only in case of using the screen turned on, open& shut can be used)
- ③ When you receive the call from Lobby or Guard Station during the conversation with the individual entrance, the electronic chime sound rings. Then, press the talk button to end the call with a guard station and press the call button again to begin the conversation with a visitor.
- ④ Screen will be turned off after 60 sec automatically, press the monitoring button to check again.
- ⑤ When press the talk button after the end of talking with a visitor, screen is turned off and all is done.

2. Call from the Lobby

- ① Visitor's image will be shown on the monitor with emitting chime sound when a visitor presses the call button.
- ② Press the talk button by watching visitor and talk with a visitor. (Screen will be turned off after 60 sec automatically from the beginning of conversation)
- ③ When you receive the call from Lobby or Guard Station during the conversation with the individual entrance, the electronic chime sound rings. Then, press the monitoring button from the video phone to finish the conversation with lobby and have a conversation with visitor.
- ④ When you press the door release button in the middle of conversation, the lobby gate will be opened with switchgear sound and the conversation will be finished.

3. Conversation with the guard station

- (1) Call from the guard.
 - ① The sound of call will be emitted when it has a call from guard.
 - ② Press the talk button to begin the conversation.
 - ③ While talking over the phone with the guard station, lower call sound of monitoring will be emitted. Then, press the monitoring button from the video phone to finish the conversation with lobby and have a conversation with visitor

PDF Compressor Free Version

(2) Calling the guard station.

- ① After pressing the talk button, press the guard button, and you can hear the call sound of guard sound.
- ② Conversation will begin when a guard station responds

4. Monitoring.

(1) In case both lobby and individual cameras are installed

Click the monitor button once in standby mode to check the images from Individual camera. Click the button twice for Lobby images and three times for returning to standby mode. (Note. it is not available during the talk)

(2) In case only lobby camera is installed.

Click monitor button once in standby mode to check the images from lobby and click the button twice to return to standby mode

5. Initializing the product

Press the talk button and door release button at the same time more than 3 seconds.

※ Caution : Monitor set and household information will be also initialized when initializing the product



5. Configuration

- Use 4 function keys positioned right side of the product.

Finishing Menu : MENU

Select or Input : SELECT

Move upward / rightward : \triangle (UP button)

Move downward / leftward : ∇ (DOWN button)

1. Screen Set

- Press the MENU button in use of conversation or monitoring and set up DOOR(LOBBY), VIDEO SET(brightness/contrast/color adjust), UTILITY(extra functions) and INFORMATION(product name and version check) function with \triangle / ∇ .

1-1.DOOR(LOBBY) VIDEO SET(brightness/contrast/color adjustment function)

- Move to DOOR(LOBBY) VIDEO SET in the screen set mode of 5-1 and after press the SELECT button, move to menu below with \triangle / ∇ button. (create LOBBY VIDEO SET during conversation or call from lobby phone.)

(1) BRIGHTNESS : adjusting brightness.

(2) CONTRAST : adjusting contrast.

(3) COLOR : adjusting color.

* How to adjust

① Move to DOOR(LOBBY) VIDEO SET in the screen set mode of 5-1 and after press the SELECT button, move to desired item with \triangle/∇ button.

② Press SELECT button to enter the menu.

③ Make use of \triangle / ∇ button to adjust.

④ Press the SELECT button.

(4) RESET : initializing screen set.

* How to set up

① Move to DOOR(LOBBY) VIDEO SET in the screen set mode of 5-1 and after press the SELECT button, move to RESET with \triangle / ∇ button.

② Press SELECT button to enter the menu.

③ Select YES on screen with \triangle / ∇ button.

④ Press the SELECT button.

※ Caution : Display setting and initializing function adjust each image (DOOR / LOBBY) separately.

(5) EXIT : Return to the screen set mode of 1.

* How to set up

① Move to DOOR(LOBBY) VIDEO SET in the screen set mode of 5-1 and after press the SELECT button, move to EXIT with \triangle / ∇ button.

② Press the SELECT button.

1-2. UTILITY (extra function)

- Move to UTILITY in the screen set mode of 5-1 and press the SELECT button to enter menu below.

(1) CHIME-BELL MUTE : set to mute the call sound.

* How to set up

① Move to UTILITY in the screen set mode of 5-1 and after press the SELECT button, move to CHIME- BELL MUTE with \triangle / ∇ button.

② Press the SELECT button

③ Set the call sound on or off with \triangle / ∇ .



: Call sound on

/



: Call sound off

- ④ Press the SELECT button.
- (2) EXIT: Return to the screen set mode of 1.
 - * How to set up
 - ① Move to DOOR(LOBBY) VIDEO SET in the screen set mode of 5-1 and after press the SELECT button, move to EXIT with \triangle / ∇ button.
 - ② Press the SELECT button.

2. System set

- In the Stand-by mode, press the MENU button on the right more than 3 sec and set HOME SET(Household information, set) and INFORMATION(Checking the name of product and version function) with \triangle / ∇ button

2-1. HOME SET (household information input function)

- Move to HOME SET in the system set mode of 5-2 and after press the SELECT button, move to SELECT button to enter menu blow.

(1) HOME ID : Building/Household number set.

* How to set up

- ① Move to HOME SET in the system set mode of 5-2 and after press the SELECT button, move to HOME ID with \triangle / ∇ button.
- ② Press SELECT button.
- ③ Current building/household is seen on the first screen.

※ Caution : default value is 1234 - 5678.

- ④ After selecting the number with \triangle / ∇ , press the SELECT button and fill it in from first. : Default on household no is 8 digit numbers. Blanks are marked with 0.

(ex : Building no : 101 Household no : 1 (0101 - 0001))

※ Wrong number can be modified with \triangleleft button.

- ⑤ When finish inputting 8-digit number, press the select button to save it.

(2) PASSWORD : changing password of a household.

* how to set up

- ① Move to HOME SET in the system set mode of 5-2 and after press the SELECT button, move to Password with \triangle / ∇ button.
- ② Move to SELECT button. (When you press the SELECT button after move to PASSWORD, get into input mode of password.)
- ③ After choose the No. with \triangle / ∇ button, press the SELECT button to input

the No. (Default value is 1234. When register new 4-digit number, it will be set automatically.)

⚠ **Caution** : Be sure to avoid numbers for security.

(On account of security, if the password is just like 0000 or 1234,4321, it will not be working.)

(3) LOBBY ID : Select the lobby phone that will do the monitoring when multiple lobby phones are connected.

(LOBBY ID select function is available from version 3.1)

* Setting

① Move to the HOME SET menu from 5-2 system setting mode. Then, click SELECT button to move to LOBBY ID menu by using Δ / ∇ button.

② Click SELECT to select the item.(Current setting will be displayed: Default 01)

③ Input 01~39 numbers(LOBBY ID that will carry out monitoring) by using Δ / ∇ buttons.

④ Click SELECT button to complete the setting.

(4) EXIT : Return to System set mode of 2.

* How to set up

① Move to HOME SET in the system set mode 5-2 and after press the SELECT button, move to EXIT with Δ / ∇ button.

② Press the SELECT button to enter the menu.

2-2. INFORMATION (checking product name and version function)

2-3. EXIT (end of System set)

2-2. After moved to EXIT in the system set mode, press the select button.

6. How to use lobby inter phone

1) When paging the household

- Enter the household number you want to call.
ex) household 101 → 1, 0, 1
- Household number appears on FND
- Press the Call button (E)
- Conversation begins when they answer.

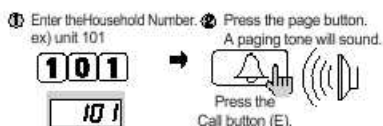

2) When paging guard station

- Press the guard button
- 'gUAd' appears on FND
- Press the Call button (E)
- Emit call house along with flickering of 'gUAd'.
- Conversation begins when guard station answers.

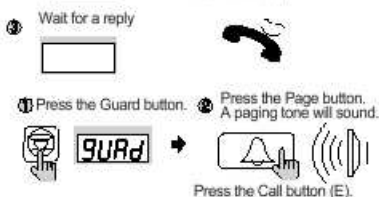

3) Opening the door with RF card

- Press the Household number
- Press the Key button (K)
- Letters of 'PASS' flicker on the FND.
- Press the 4-digit password.
- Appears '----' on the FND.
- Press the Call button
- Door is open with flickering of 'oPEn' on FND.

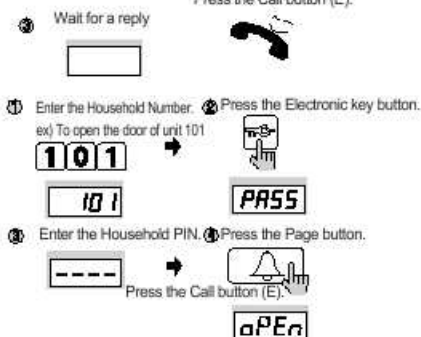

[Reference for use]

Contact guard station or management station if you don't remember the password

4) Opening the door with registered RF card (optional function)

- Put the RF card on the sensor positioned right below of camera lens to open the door. Door will be opened along with a message of 'oPEn' on FND.



[Reference for use]

1. If you try to open the door with unregistered RF card, it will be notified to guard station. Please try again after registering it at the guard station or management office.
2. If RF card still doesn't work after proper registering procedure, it is not usable card.

7. Installation method

1. Installation Method of camera monitor

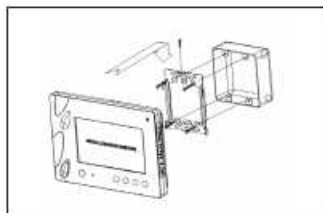

⚠ Caution

- ① Keep out of direct sunlight.
- ② Proper installation height is at 145~150Cm from the ground.
- ③ When to install it, avoid the place where can be influenced by Magnetism Humidity, Direct light and heater

2. Installation Method of camera

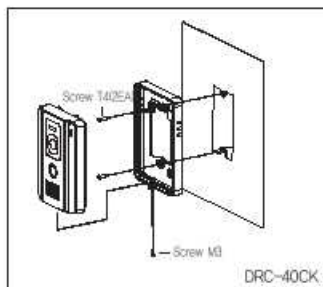

⚠ Caution

- ① Keep out of direct sunlight or backlight.
- ② Keep the lens cleaned.

8. Wiring method

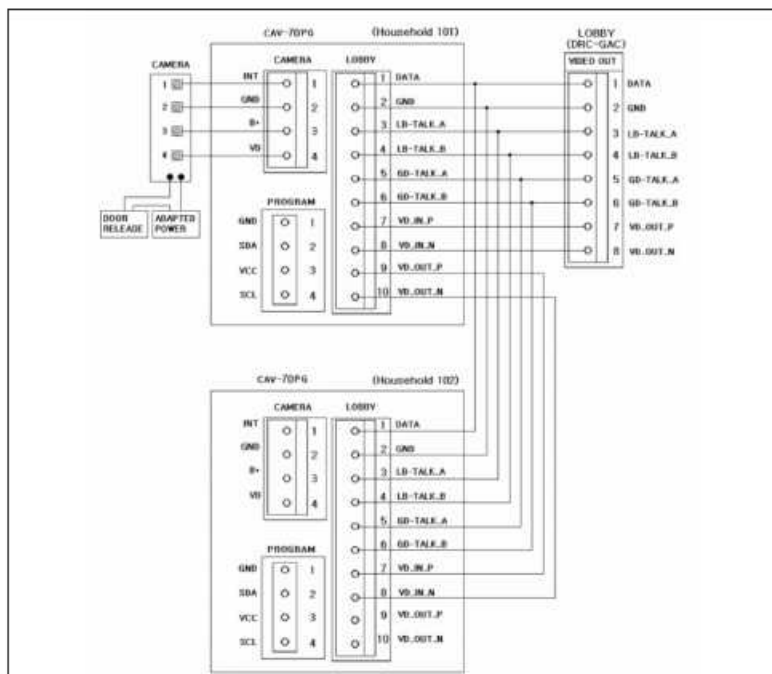

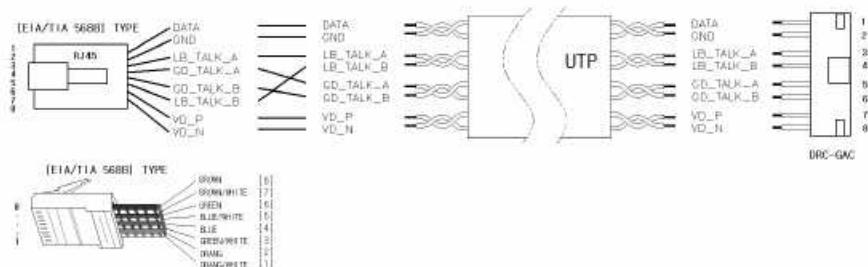

2. Cautions for wiring

- 1) If it is to be installed near high voltage line, please use coaxial cable for grounding.
- 2) Keep the cable out of the sheath exposure to prevent to be shorted.
- 3) Be sure to turn off the monitor before you connect the monitor with cameras.
- 4) Be careful of the polarity of the cable when you connect the monitor with cameras.



9. Contents

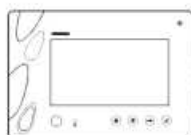

CAV-70PG



Wall mount bracket



User manual



(T)4 X 18mm
Screws for mounting



(M)3 X 6mm
Screws for main body



4P(1EA),10P(1EA)
Connector



10. Instructions for use

1. Turn on the power switch.
2. Please contact your local agent for product maintenance when you have a problem in use of CAV-40GQ
3. For your safety, power switch with a safety device must be used in your building.
4. Unplug before installing or repairing the product.
5. Unplug when you connect monitor with door cameras.



11. Miscellaneous

- Please carefully read this User's Guide before calling service man

After checking the entire check list, please contact customer service center. We will do our best to make you satisfy with our services.



12. Specifications

Spec	Model	CAV-70PG
Transmission style		CAMERA 4 lines(polar), LOBBY 8 lines(polar)
Rated Voltage		100-240V~, 50/60Hz (FREE VOLTAGE)
Power consumption		MAX : 15W, Stand-by : 4W
Conversation		HANDS FREE mode(Voice Switch circuit)
Display		17.78Cm(7") COLOR TFT-LCD (DIGITAL)
Calling sound		Entrance : Electronic chime 3 tone melody, 2 Guard station : Melody
Talk duration		Standby : 30sec Conversation : 60sec Guard station : 3min
Distance		Individual camera : 28m (Ø0.5) Common lobby : 300m (UTP) Guard station : 1Km
Working Temperature		0 ~ +40°C (32°F ~ 104°F)
Dimension		243.0(W) X 168.0(H) X 30.0(D)

COMMAX

COMMAX Co.,Ltd.

513-11, Sangdaewon-dong, Jungwon-gu, Seongnam-si, Gyeonggi-do, Korea

Int'l Business Dept. Tel. : +82-31-7393-540~550 Fax. : +82-31-745-2133

Web site : www.commax.com